

**HALCYON**  
**FLAVOURS**  
Party for your taste buds

**Halcyon Food & Beverages Pvt. Ltd.**

# 8-3-826/A, Beside Priya Arcade, Adjacent Lane to Indian Bank,  
Yellareddyguda, Srinagar Colony,  
Hyderabad - 500073, Telangana State, India

Contact Us : 95507 27374 | 99895 37374

95504 26543 | 90000 33556

Email: [info@halcyonflavours.com](mailto:info@halcyonflavours.com)

[www.halcyonflavours.com](http://www.halcyonflavours.com)





# PROMOTIONAL

## SHOWCASE

青岛益达制冷设备有限公司  
QINGDAO EASYBEST REFRIGERATION EQUIPMENT CO.,LTD.

TEL: +86-533-89081188  
FAX: +86-533-89081177779  
Sales Hotline: +86-532-67903138  
+86-532-87905727

Service Hotline: +86-15806883257  
E-mail: info@easybest.com  
Http://www.easybest.com  
Http://easybest.cn.1688.com

Qingdao Industrial Area  
Chengyang District  
Qingdao, Shandong  
China 266105

Free Service Call  
400-069-6799



2018.8 Version

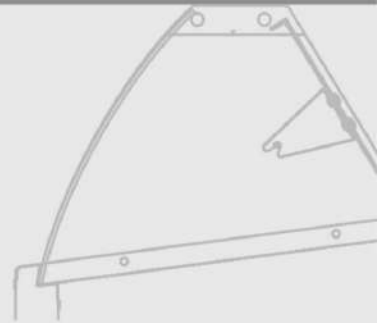

## THE DETAIL OF PERFECTION 完美源于细节

青岛探达制冷设备有限公司拥有一个具有无限潜力的管理团队。成长迅速，不断壮大。这个团队拥有责任感、勇于奉献的企业精神和对建设者的热情。

青岛探达具有前瞻性的中心价值观，包括他们一直遵守的理念：热情、真诚、诚实守信、不断创新、追求卓越。品质至上、团队合作、尊重、和谐。时刻关注着市场，最大程度的满足客户的需求。

多年来，在研发方面始终坚持以一线需求为导向，我们的研发团队研发有效的解决方案，不断创新产品结构，以满足市场日益多样化的需求。多年来，我们一直秉持对社会的责任感，

让所有产品均按照国际标准生产，先后通过了CE认证、CCC认证、ROSH认证、UL认证、ETL、SANITATION/ISO9001等产品的企业认证。这为开拓欧洲、东南亚、日韩、北美等国际市场以及国内市场奠定了良好的基础。

青岛探达制冷设备有限公司注重产品的售后服务，我们为客户提供最专业的产品。公司产品一直奉行行业领先技术水平和服务水平的原则。

Qingdao Easy Best Refrigeration Equipment Ltd. is first of all, a wonderful team of people, who have created a really quickly grow. A young and dynamic group, born from the entrepreneurial vision and passion of its founder.

The core values that distinguish Qingdao Easy Best Refrigeration Equipment Ltd are the Competence, Passion, Flexibility, Ambition to do better, Transparency, Quality, Respect, Smile and the security of always having the highest attention to the needs of the customer.

Continued investment in R & D allow us to offer a range of products more technological vanguard. Our orientation is to offer new and efficient technological and aesthetic solutions satisfying the new and sophisticated demands from the market. We are a reference point since some year in China for an industry more and more dynamic.

All Easy Best products are produced in strict accordance with international standard, having CE, CCC, ROSH certification, USA & Canada ETL, ETL SANITATION, ISO9001 and TUV NEMETRO and we have customer from many country in Europe, North and Southeast Asia, South America, North America.

Qingdao Easy Best Refrigeration Ltd aims to give to the future professionals Gelato and Pastry customers, products that are always the expression of high technology and aesthetic innovation.

Qingdao Easy Best Refrigeration Ltd aims to give to the future professionals Gelato and Pastry customers, products that are always the expression of high technology and aesthetic innovation.

CE CCC TÜV NEMETRO ISO9001:2000



MAGIC  
GELATO SHOWCASE



- Verified 验证
- Auto Defrosting 自动化霜
- Efficient RADIA 辐射加热技术
- Opening Glass 玻璃开盖方式
- Temperature 工作温度: 18-22°C
- Climate: class C/RHS 气候等级/湿度: 30%/60

1. Hermetic compressor: High refrigerating capacity, low consumption and low noise levels.
2. Automatic inversion cycle defrost, fast defrosting time, that doesn't affect product characteristics.
3. Glasses: Safety double glass with Heating element, can work very well in high humidity environment.
4. Colors are available upon your request.
5. The showcase can be made for Round basket use.

1. 全封闭压缩机和低温压缩机, 全封闭压缩机, 节能, 低噪音。
2. 全封闭的循环化霜, 不影响产品性能。
3. 玻璃: 双层中空钢化玻璃加热玻璃, 可在高湿度环境下工作。
4. 颜色可根据客户要求定制。
5. 该产品可以定制圆篮使用。

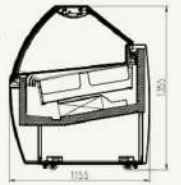

MODEL 型号	Dimensions / 尺寸: LxWxH (mm)	Weight/net / 净重 (kg)	Voltage V/ph/Hz 电压 V/相/Hz	Input power(W) 输入功率(W)
12	1182*1155*1355	236/285	220-240/1/50	1400
16	1612*1155*1355	285/345	220-240/1/50	1600

MAGIC



ERIC  
GELATO SHOWCASE



- Ventilated 风冷
- Auto. Defrosting 自动化霜
- Refrigerant R604A 制冷剂 R604A
- Temperature 工作温度 -18~-12°C
- Climatic class 气候带 冷藏/冷冻/保鲜

1. Hermetic compressor. High refrigerating capacity, low consumption and low noise levels.
2. Automatic inversion cycle defrost, fast defrosting time, that doesn't affect product characteristics.
3. Glasses: Safety double glass with Heating element, can work very well in high humidity environment.
4. Straight front glass for the best visibility.
5. Colors are available upon your request.

1. 全密封压缩机。制冷容量大，能耗低，噪音小。
2. 全自动的倒循环化霜，化霜时间短，不影响产品品质。
3. 玻璃：中空安全钢化玻璃带加热元件，可在高湿度环境下工作。
4. 平直式前玻璃使产品有更好的展示效果。
5. 颜色可根据客户要求。

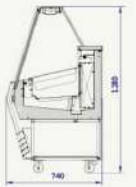

PANS MODEL / 柜型图			
Model 6: 1290*740*1280 (mm)	Model 7: 1460*740*1280 (mm)	Model 9: 1818*740*1280 (mm)	

MODEL 型号	Dimensions LxWxH (mm) 尺寸: 长*宽*高 (mm)	Weight net/gross 净重/毛重 (kg)	Voltage V/Hz/Ph 电压 V/Hz/Ph	Input power (W) 输入功率 (W)
6	1290*740*1280	135/152	220-240/1/50	696
7	1460*740*1280	160/180	220-240/1/50	856
9	1818*740*1280	200/225	220-240/1/50	880

BRIO



ICE CREAM CART  
GLAZIO SHOWCASE



- Ventilator 风扇
- Defrosting 自动化霜
- Refrigerant R600a R134a
- Temperature 工作温度 -18~-13°C
- Climatic class 气候等级 SN-ET

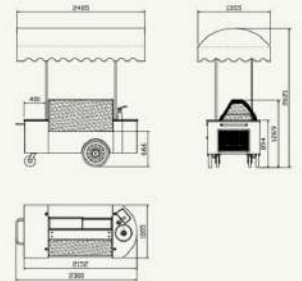

1. Fully enclosed import brand refrigeration compressor unit; hermetic compressor; high efficiency, low consumption, low noise.
2. Automatic reverse cycle defrost, which do not affect product performance.
3. Washing sprayer as standard.
4. Cart and roof color available upon your request.

1. 全新原装进口品牌压缩机：全封闭压缩机，高效、节能、低噪音。
2. 全自动逆循环化霜，不影响产品性能。
3. 产品带有洗勺装置。
4. 车身及顶棚颜色可按要求定做。

INS MODEL / 内部图	
	12
	9
	5

MODEL / 型号	Dimensions : L*W*H (mm) / 尺寸 : 长*宽*高 (mm)	Weight/net/gross(kg) / 净重/毛重 (kg)	Voltage V/Ph/Hz / 电压 V/相/Hz	Input power (W) / 输入功率 (W)
12	2450*1150*2621	547/613	220-240/1/50	1300

IC CART

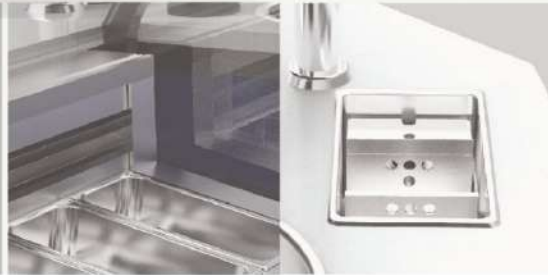



SMART  
VENTILATED



SAMOAV  
VENTILATED



EKOS  
STATIC

- EKOS 静音 静音
- SMART SAMOAV 通风型 通风
- Auto Defrosting 自动除霜
- Refrigerant R404A 制冷剂R404A
- Temperature 温度 0-15°C
- Climate class T3EN 气候等级 T3/EN



1. Fully enclosed import brand refrigeration compressor unit, hermetic compressor, high efficiency, low consumption, low noise.
2. Automatic reverse cycle defrost, which do not affect product performance.
3. Large storage space, having underneath compartment for the storage of ice cream pans if depth is less than 120mm can put two layer pans.
4. Direction wheels with brake for easy moving.

1. 全封闭进口知名压缩机：全封闭压缩机，高效，低耗，低噪音。
2. 全自动逆循环除霜，不影响产品性能。
3. 储物空间大，箱体下部存放冰盘空间小于120mm可存放两层冰盘。
4. 带有刹车功能的万向轮，可自由移动展示柜。



MODEL 型号	Dimensions: LxWxH (mm) 尺寸: 长x宽x高 (mm)	Weight (net/gross) (kg) 净重/毛重 (kg)	Voltage V/Ph/Hz 电压 V/相/Hz	Input power (W) 输入功率 (W)
SMART	660*716.5*1115	95/120	220-240/50	604
SAMOAV	1170*670*1115	180/240	220-240/50	675
EKOS	1170*670*1115	160/180	220-240/50	475



- Ventilated 风冷
- Defrosting 自动化霜
- Refrigerant R600A 环保制冷剂
- Temperature 工作温度 -15~-12℃
- Climate class T2RH5 热带潮湿气候带/级

1. Hermetic compressor: High refrigerating capacity, low consumption and low noise levels.
2. Automatic inversion cycle defrost, fast defrosting time, that doesn't affect product characteristics.
3. Glass: Safety double glass with Heating element, can work very well in high humidity environment.
4. Best Performance with small dimension.
5. Colors are available upon your request.

1. 全封闭进口制冷压缩机：制冷容量大，耗电低，噪音低。
2. 全身中温铜管化霜，不影响产品品质。
3. 玻璃：双道安全钢化玻璃带化霜膜，可在高湿度环境下工作。
4. 外形小巧，适用范围广。
5. 颜色可根据需求定制。



PNAS MODEL / 柜型	10	12
Model 10 (880*1334)	10	12
Model 12 (980*1334)	7	9
Model 10 (880*1334)	7	9

ENERGY



MODEL 型号	Dimensions: LxWxH (mm) 尺寸: 长*宽*高 (mm)	Weight (net/gross) (kg) 净重/毛重 (kg)	Voltage V/phi/Hz 电压 V/phi/Hz	Input power (W) 输入功率 (W)
10	1029*880*1334	170/220	220-240/1/50	1150
12	1229*980*1334	200/250	220-240/1/50	1300

G3

GELATO SHOWCASE



G3-ST



G3-SS



- 1. Stainless steel shell
- 2. Aluminum doorframe
- 3. Double glass with heating element
- 4. Slow descending control of glass

- 1. 不锈钢外壳
- 2. 铝制门框
- 3. 双层中空电加热玻璃
- 4. 玻璃缓慢升降

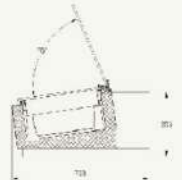

G3

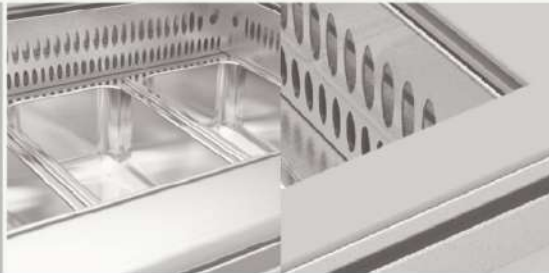

MODEL 型号	Dimensions / 尺寸: 长*宽*高 (mm)	Weightnet / gross(Kg) 净重/毛重 (Kg)	Voltage V/phase/Hz 电压 V/相数/Hz	Input power(W) 输入功率(W)
G3	671*751*380	50/58	220-240V/1/50	500

CUBE

GELATO SHOWCASE



Verified  
认证  
Refrigerant R600A  
制冷剂 R600A  
Temperature  
工作温度 -15~18°C  
Climate class Climate  
气候类别/温度 D / 10

- 1. Hermetic compressor: High refrigerating capacity, low consumption and low noise levels.
- 2. Glass door automatic close.
- 3. Glasses: Safety glass with Heating element can work very well in high humidity environment.

- 1. 全封闭压缩机容量大、能效低、噪音低。
- 2. 玻璃门自动关门。
- 3. 玻璃：中钢化玻璃钢化玻璃。

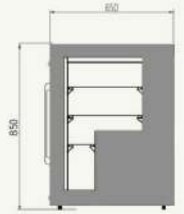

CUBE

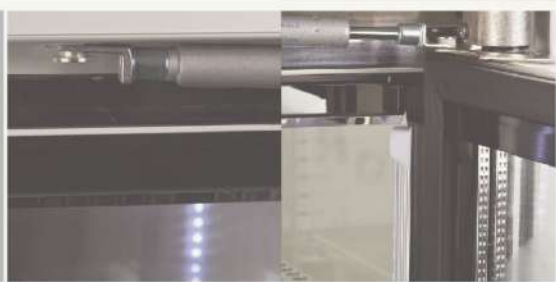

MODEL 型号	Dimensions LxWxH (mm) 尺寸-长*宽*高 (mm)	Weight/net./gross(kg) 净重/毛重 (kg)	Voltage V/Ph/Hz 电压 V/相/Hz	Input power (W) 输入功率 (W)
1008T	650*650*850	230/280	220V/1/50	800



*...Making The BEST In The EASY Way...*

**HALCYON  
FLAVOURS**  
*Party for your taste buds*

**BHOLAKUMAR SONAR**  
AREA MANAGER - SALES & SERVICE  
99895 37374

Office : 95507 27374, 90320 07374  
bholakumar@halcyonflavours.com | www.halcyonflavours.com

#8-3-826/A, Beside Priya Arcade, Adjacent lane to Indian bank  
Yellareddy guda, Srinagar Colony, Hyderabad 500073,  
Telangana State, India.